

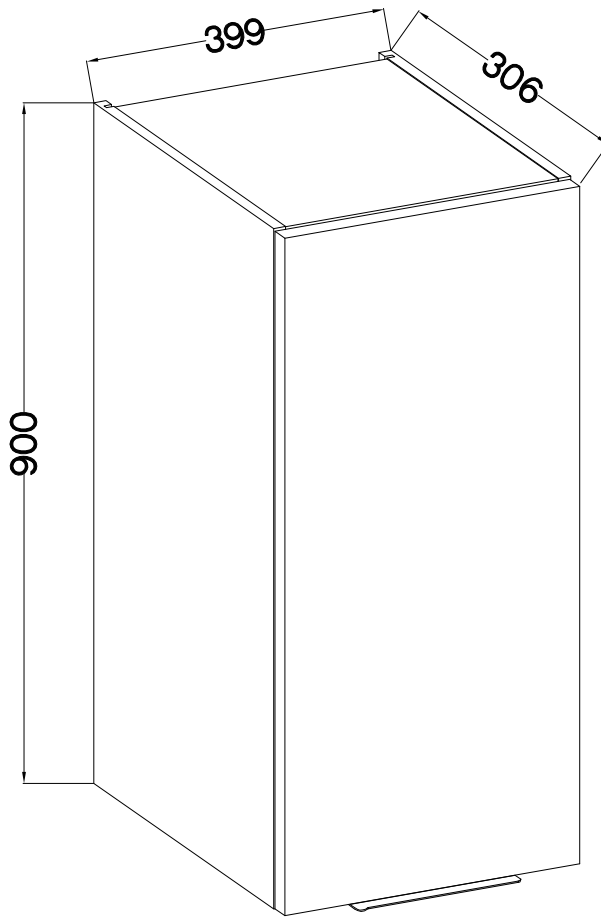

896x396  
FRONT

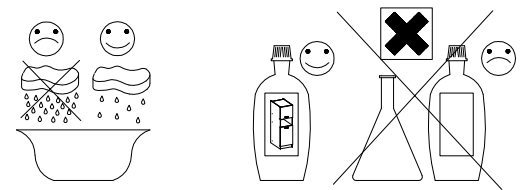

KUH.71155

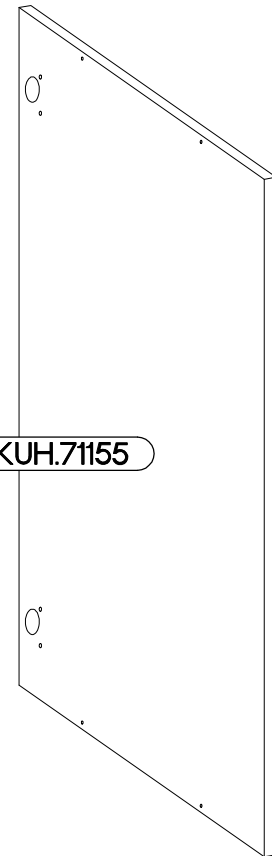

L=192mm	±7/2mm
	
S	J5
1	2

Ersatzteil Nummer	Dimension
KUH.71155	896x396x16

ISM-KUH-02036

1

±35/0mm HG 2	±3.5x13mm P5 4	±7/2mm J5 2
--------------------	----------------------	-------------------

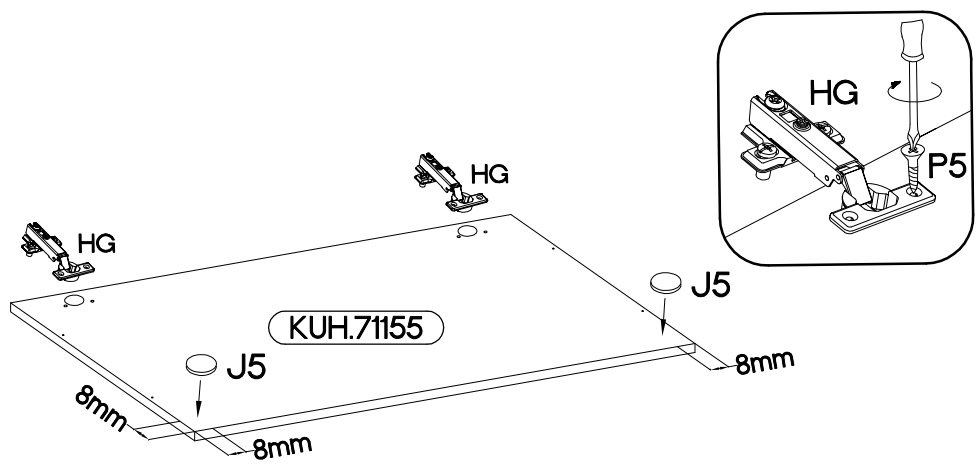
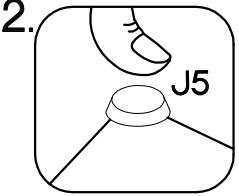
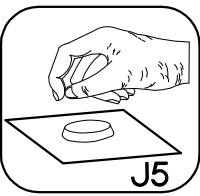

2

L=192mm
S 1

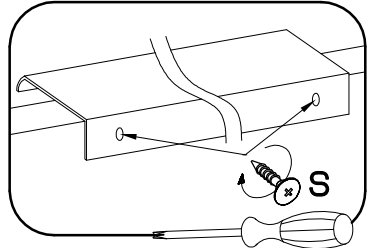
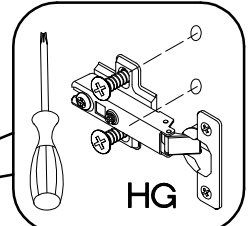
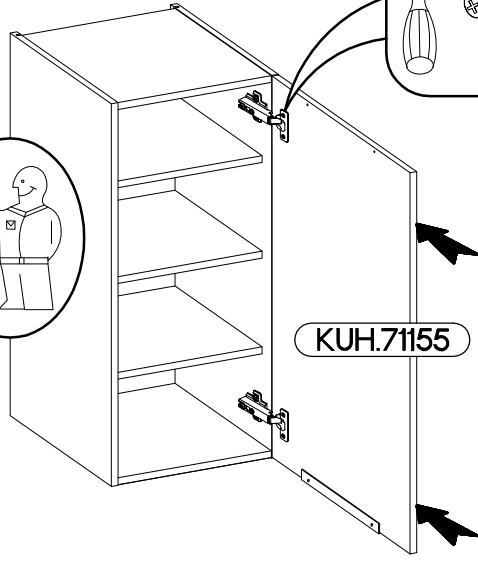
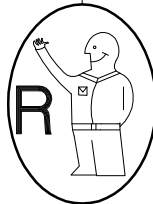
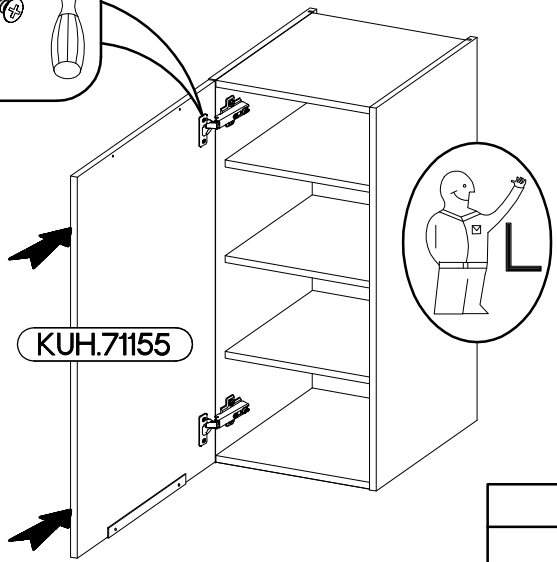
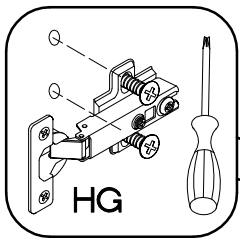

VARIANT HIGH GLOSS

